



Fabbrica Italiana Ruote

www.fir.it

INFORMAZIONI TECNICHE • TECHNICAL INFORMATION



FORO PASSANTE

Consigliato per usi intermittenti. Rumorosità e cigolio possono verificarsi in caso di utilizzo in ambienti sporchi o polverosi.

PLAIN BEARING

Suggested for intermittent wheel use, it will not require further lubrication. However axle tube wear and squeaking can be evident in dusty and gritty work conditions.

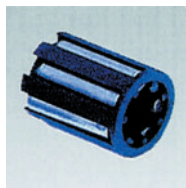

RULLI FERRO

Consigliato per usi frequenti. Ideale per applicazioni con elevato carico. La gabbia a rulli è protetta da entrambi i lati. Buono spunto di partenza.

ROLLER BEARING

Suggested for frequent wheel use, it will not require further lubrication. It is ideal for applications involving high radial and low axial loads. Roller bearings are shielded to retain the bearing and to avoid penetration of dust and dirt. Low inertial force.



RULLI INOX

Consigliato per usi frequenti. Ideale per applicazioni con elevato carico. La gabbia a rulli è protetta da entrambi i lati. Buono spunto di partenza.

STAINLESS STEEL ROLLER BEARING

Suggested for continuous wheel use, it will not require further lubrication. It is ideal for applications involving high radial and low axial loads. Roller bearings are shielded to retain the bearing and to avoid penetration of dust. Low inertial force.



CUSCINETTI A SFERE

Consigliato per usi continui. Ideale per applicazioni con massimi carichi. I cuscinetti sono schermati o stagni per evitare l'introduzione di sporco e polvere. Ottimo spunto di partenza.

BALL BEARINGS

Suggested for continuous wheel use, they do not require further lubrication. They are ideal for applications featuring high radial and axial loads. Ball bearings are shielded to avoid penetration of dust and dirt. Waterproof version also available. Very low inertial force.



BOCCOLE TEFLON

Consigliate su ruote fenoliche per una buona scorrevolezza in ambienti ad alte temperature.

HT SELFLUBE BUSH

Specially designed and developed to fit phenolic wheels, these bushes are self-lubricating even at high temperatures.



FRENO ANTERIORE

Disponibile su supporti tipo leggero, industriale, medio e pesante; blocca simultaneamente la rotazione della ruota e del supporto. Consigliato per carrelli a spinta. Per diametri da 80 a 150 disponibile blocco direzionale.

FRONT TOTAL BRAKE

Available for light, industrial, medium and heavy duty castors. These simultaneously lock wheel from rolling and bracket from swiveling. The pedal does not require any further lubrication. Available with directional lock device only in diameters from 80 to 150 mm.



FRENO POSTERIORE

Disponibile su supporti tipo medio, pesante e superpesante; blocca simultaneamente la rotazione della ruota e del supporto. Con possibilità di regolazione. Consigliato per carrelli trainati.

REAR TOTAL BRAKE

Available for medium, heavy and extra heavy duty castors. These simultaneously lock wheel from rolling and bracket from swiveling. The steel pedal does not require any further lubrication and is adjustable.



PARAFILI

Disponibili per la maggior parte di ruote proteggono il mozzo dall'introduzione di fili, sporco ecc. Disponibili in acciaio zincato o acciaio inox.

THREADGUARDS

Available for all wheel ranges, starting from 80 mm diameter, they can be in zinc or stainless steel. They protect the wheel hub from dust, threads etc.



ASSE E DADO

Disponibili in acciaio zincato o acciaio inox. Utilizzati per fissare la ruota al supporto. Dadi autobloccanti su richiesta.

SCREW AND NUT

Available in zinc or stainless steel, they are used to fix the axle bush and wheel to forks. Self locking nuts are available on request.



BUSSOLA

Disponibile in acciaio ed acciaio inox, tubo di rotazione della ruota sul supporto. A richiesta è disponibile in acciaio cromato.

AXLE BUSH

Available in steel or stainless steel, they are used with plain bearing, roller bearing and ball bearing hubs. Chrome treated bushes are available on request.

SCORREVOLEZZA

E' la forza necessaria a mantenere un carrello in movimento a velocità costante. La resistenza al rotolamento diminuisce aumentando il diametro della ruota e dipende dal sistema di rotazione del mozzo, dalle condizioni della superficie e dalla portata.

ROLLING RESISTANCE

Rolling resistance is the force necessary to maintain the equipment at a constant speed. This force is inversely proportional to wheel diameter and depends on the type of bearing. It also depends upon the surface conditions and load.

SPINTA / TRAZIONE

Tutte le ruote e tutti i supporti F.I.R. sono prodotti esclusivamente per spinta / trazione manuale. Raccomandiamo di rivolgersi al produttore per ruote e supporti da utilizzare per la movimentazione motorizzata.

MOTIVE POWER

All F.I.R. castors and wheels are specifically manufactured for manual propulsion. Please refer to the manufacturer for wheels and castors required for continuous applications or powered propulsion.

VELOCITÀ

La portata di ruote e supporti indicata sul presente catalogo è riferita a una velocità max di 4 Km/h (1,1 m/s).

SPEED

F.I.R. castors and wheels nominal load capacities relate to a maximum speed of 4 Km/h (1,1 m/s) - 2,49 mph (1,2 yds/s)

PORTATA

La F.I.R. raccomanda di calcolare la portata di ogni singola ruota (per carrelli a 4 ruote) in base alla formula seguente:

$$\frac{\text{Peso del carrello} + \text{carico solido}}{3}$$

$$\frac{\text{Peso del carrello} + \text{carico liquido}}{2}$$

Per carichi ai limiti delle portate indicate o utilizzi estremi, rivolgersi in Azienda

LOAD CAPACITY

F.I.R. recommends calculation of load capacity on a single castor by use of the formula:

$$\frac{\text{Equipment weight} + \text{solid load}}{3}$$

$$\frac{\text{Equipment weight} + \text{liquid load}}{2}$$

Please apply to our technical staff in relation to load requirements close to the maximum carrying capacities

CONDIZIONI DI COLLAUDO

Le portate e i collaudi sono determinati secondo le normative ISO 22884, UNI EN 12527, UNI EN 12532 e si riferiscono a condizioni di utilizzo normali ossia:

- 1) CARICO DI PROVA= portata nominale
- 2) VELOCITÀ DI PROVA= 4Km/h ±50 m/h
- 3) TEMPERATURA AMBIENTE= 20°C ±10°C
- 4) PAVIMENTO in buono stato, duro e compatto, con ostacoli aventi le seguenti caratteristiche: altezza pari al 5% del diametro della ruota, per fascia di rotolamento morbida (fino 90 Shore A); pari al 2,5% del diametro della ruota, per fascia di rotolamento dura (oltre 90 Shore A).
- 5) CICLO: sequenza di cicli di 4 min. massimo ciascuno compreso un tempo di arresto massimo pari al 25% della durata del ciclo.

TEST CONDITIONS

Load capacities and tests are determined according to the ISO 22884, UNI EN 12527, UNI EN 12532 Standards. They refer to use under normal conditions:

- 1) TEST LOAD = nominal load
- 2) TEST SPEED = 4Km/h ±50 m/h - 2,49 mph ±55 yds/h
- 3) TEST TEMPERATURE = 20°C ±10°C - 68°F ±50°F
- 4) SURFACE in good conditions, hard and solid, with obstacles having the following characteristics: height equal to 5 % of wheel diameter in the case of soft tread (up to 90 Shore A); equal to 2.5% of wheel diameter, in the case of hard tread (beyond 90 Shore A).
- 5) CYCLE: sequence of cycles each 4 minutes maximum, included a maximum pause time of 25% of the cycle duration.

CONDIZIONI DI UTILIZZO

Le ruote e supporti F.I.R. sono prodotti con materiali di prima scelta e procedimenti di produzione controllati. Le condizioni standard relative ad un "normale funzionamento" sono:

- temperatura ambiente: da +5 °C a +30 °C
- umidità relativa: da. 40% a 80%
- nessuna esposizione diretta alla luce solare
- assenza di agenti chimici aggressivi

ENVIRONMENT CONDITION

F.I.R. castors and wheels are manufactured in controlled production processes using the highest quality materials. The following standard conditions are considered as "normal working conditions":

- temperature range: +5 °C to +30 °C
+41°F to +86° F
- relative humidity: 40% to 80%
- no direct sunlight exposure
- no aggressive physical or chemical agents

IMMAGAZZINAGGIO

La F.I.R. raccomanda di immagazzinare i propri prodotti in ambiente ventilato, con temperatura compresa fra -10 °C e +30 °C, senza umidità e protetti da polvere; evitare esposizione ai raggi solari per un lungo periodo di tempo.

STORAGE

F.I.R. recommends that products are stored in a ventilated environment, with temperature between -10 °C -50° F and +30 °C - +86° F, without high humidity and protected from dust. Do not store for long periods of time, and protect from direct sunlight.

DISPOSITIVO FRENANTE

IMPORTANTE: i supporti F.I.R. sono disponibili con dispositivo frenante totale e sono idonei per stazionamento del carrello su superfici con pendenze massime del 3% una volta verificato che almeno due ruote con dispositivo siano a contatto con il suolo.

BRAKING DEVICE

IMPORTANT: F.I.R. castors are available with total locking systems; all locking devices are suitable for equipment in stationary conditions. Never use the locking devices to reduce speed during normal work and never use them on gradients in excess of 3%. These conditions apply to all equipment with at least 2 castors fitted with locking devices in contact with the floor.

I FRENI

I supporti F.I.R. possono essere forniti con freno anteriore o posteriore. L'azionamento dei freni blocca contemporaneamente il movimento della ruota e la rotazione della forcella. Il funzionamento del pedale è garantito anche in condizioni ambientali critiche. L'azionamento e disazionamento del freno è facile e sicuro. Si raccomanda l'utilizzo del freno anteriore o posteriore quando:

- Freno anteriore: il supporto deve essere applicato in carrelli che normalmente sono spinti
- Freno posteriore: il supporto deve essere applicato a carrelli che normalmente sono tirati

I freni anteriori e posteriori non dovrebbero mai essere usati per decelerare il carrello. La loro funzione è quella di mantenere il carrello in posizione quando è fermo.

TOTAL LOCK BRAKE

F.I.R. brackets can be supplied with a front or rear total lock brake. These simultaneously lock rolling of the wheel and swivelling of the brackets. The pedal is guaranteed to work in all conditions without locking even in the most adverse environments. Locking and unlocking are very easy and safe. Front and rear total lock brakes are recommended in the following circumstances:

- Front braked brackets: these should be fitted under trolleys which will normally be pushed.
- Rear braked brackets: these should be fitted under trolleys which will normally be pulled.

Total front/rear lock brakes should never be used to reduce the speed of the equipment, but are designed and fitted to hold the position of the trolley once stopped.

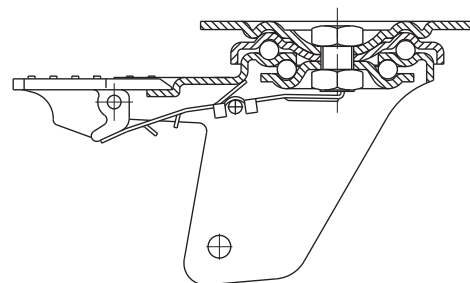
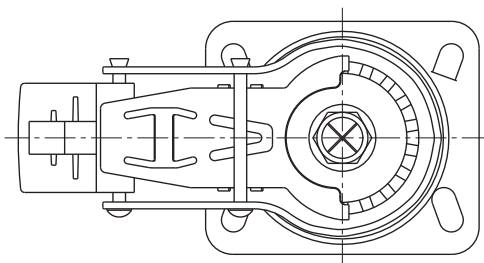
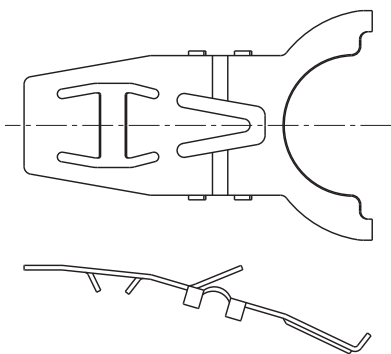

LUBRIFICAZIONE PERIODICA

Sebbene le ruote e supporti F.I.R. siano preingrassati, si consiglia una lubrificazione periodica con alcune gocce d'olio per prevenire danni o bloccaggi in caso di utilizzo in condizioni critiche.

BRACKET AND WHEEL LUBRICATION

Although F.I.R. castors and wheels are maintenance-free, we recommend that the lubrication be checked periodically. A few drops of machine oil may be used to prevent damage when castors are used in severe conditions.

APPLICAZIONI / CONDIZIONI SPECIALI

Per evitare qualsiasi tipo di inconveniente e per utilizzare il miglior prodotto in ciascun campo d'applicazione, consigliamo di interpellare il nostro servizio tecnico.

SPECIAL APPLICATION AND/OR ENVIRONMENT

In order to prevent damage and to provide the appropriate castor and wheel in any application, F.I.R. recommends to contact the technical department for information on material resistance and with regard to any special requirements you may have.

I SUPPORTI

BRACKET INFORMATION

I supporti F.I.R. sono prodotti secondo le normative ISO 2184, riguardanti le dimensioni e i fori delle piastre. La nostra gamma di supporti include anche piastre e forcelle con le dimensioni richieste dal mercato nord americano.

F.I.R. brackets are manufactured according to ISO 2184 standards with respect to the top plate and hole dimensions. In response to customer demand, F.I.R. also manufactures a range of plates and forks according to North American specifications.

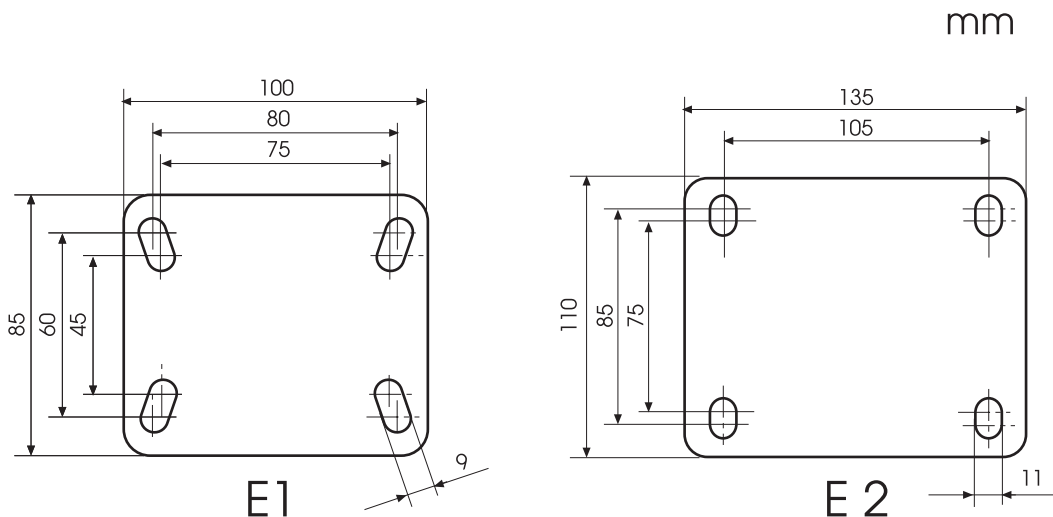

DIMENSIONI DELLE PIASTRE
POSIZIONE E DIMENSIONE DELLE ASOLE
DIMENSIONE INTERASSE ASOLE

TOP PLATE DIMENSIONS
HOLE DIMENSIONS AND POSITIONS
PLATE HOLE DISTANCE

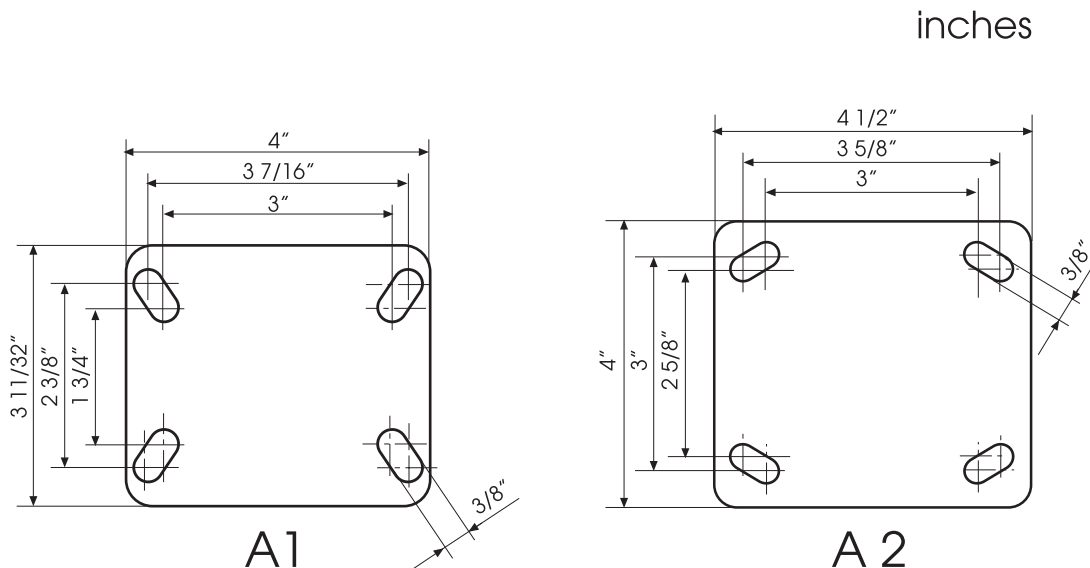
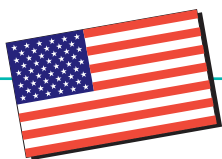
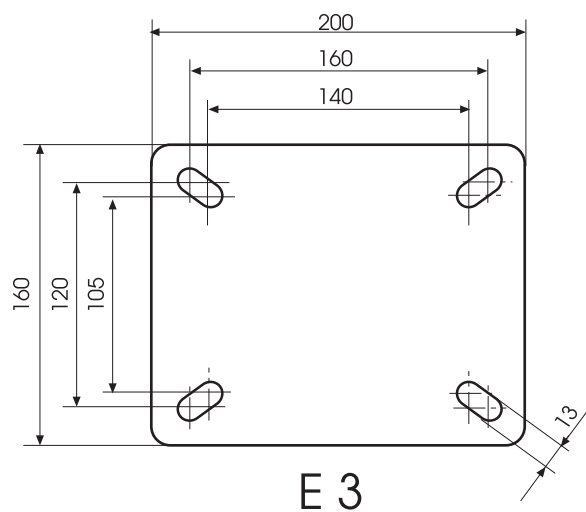

MONTAGGIO DEI SUPPORTI AL CARRELLO

F.I.R. assicura l'ottimale funzionamento e una lunga durata di ruota e supporto, qualora siano rispettate le seguenti condizioni:

- la ruota deve essere applicata ad un supporto adatto, utilizzando accessori originali e di dimensioni adeguate.
- verifica della libera rotazione dopo aver fissato la ruota.
- i supporti a piastra devono essere fissati utilizzando viti, dadi e rondelle del tipo, dimensione e quantità indicati dal costruttore.
- i supporti a codolo devono essere applicati in strutture tubolari aventi una tolleranza molto stretta.
- i supporti a foro passante devono essere fissati mediante una vite di dimensione e tipo indicati dal costruttore
- la base superiore dei supporti deve aderire perfettamente e per intero al piano di montaggio.

FITTING BRACKETS TO EQUIPMENT

We guarantee the performance and the life of our wheels and castors, in line with the product warranty, providing the following conditions are fulfilled:

- *the wheel must be fitted into the correct fork using the original axles, bolts and nuts of the correct dimensions*
- *verification of free rotation of the wheel after fitting*
- *the top plate castor must be fitted with bolts, nuts and washers of the correct size and quantities indicated by the manufacturer.*
- *solid stem castors must be fitted into tubular structures with tight tolerance.*
- *mounting plane surface of bolt hole or threaded castors must adhere perfectly to the mounting plane of the equipment.*
- *bolt hole castors must be fitted using a bolt as recommended by the manufacturer*

STANDARD

Le ruote ed i supporti F.I.R. sono prodotti seguendo anche i seguenti standard ISO e CEN/TC 324:

- ISO 2163
- ISO 2175
- ISO 2184 part 1
- ISO 22884
- ISO 3102
- EN 12527
- EN 12530
- prEN 12531
- prEN 12532

ADDITIONAL STANDARDS

F.I.R. wheels and brackets are also manufactured according to the following ISO and CEN/TC 324 Standards:

- *ISO 2163*
- *ISO 2175*
- *ISO 2184, part 1*
- *ISO 22884*
- *ISO 3102*
- *EN 12527*
- *EN 12530*
- *prEN 12531*
- *prEN 12532*



I prodotti F.I.R. sono prodotti in ottemperanza alla Direttiva Europea 2000/53/CE relativa ai veicoli fuori uso ed alla Direttiva Europea EU 2002/95/CE (RoHS) "Restrizione dell'uso di sostanze pericolose in apparecchiature elettriche ed elettroniche".

F.I.R. products are manufactured in compliance with European Directive 2000/53/CE on end-of-life vehicles and European Directive EU 2002/95/CE (RoHS) "Restriction of the use of certain hazardous substances in electrical and electronic equipment".



FIR per l'ambiente

FIR coniuga qualità, innovazione e rispetto per l'ambiente.

A questo proposito, abbiamo identificato i prodotti che possono essere riciclati o rigenerati e ne incoraggiamo l'utilizzo.

FIR for the environment

FIR combines quality, innovation and respect for the environment.

To this end, we have identified those products that may be recycled or regenerated. We strongly encourage use of these products.

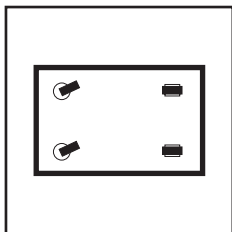

2 SUPPORTI GIREVOLI + 2 SUPPORTI FISSI

Questa soluzione offre una buona capacità di carico e manovrabilità. E' una soluzione sicura contro eventuali pericoli di ribaltamento. E' l'applicazione più praticata su carrelli per uso industriale. Consigliamo la spinta o trascinamento dal lato delle due ruote girevoli. La capacità max di portata è data da = $\frac{\text{peso totale}}{3}$

2 SWIVEL BRACKETS AND 2 FIXED BRACKETS

This solution provides a good load capacity and manoeuvrability; accurate steering is guaranteed. This is the most practical solution for use in industrial trolleys. We suggest that the equipment be pushed from the side of the 2 swivel wheels. Maximum load on each wheel is given by = $\frac{\text{total weight}}{3}$

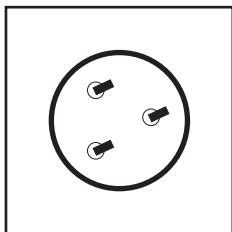

3 SUPPORTI GIREVOLI

Questa soluzione offre una buona capacità di carico ed un'ottima manovrabilità in spazi limitati. I carrelli con questa configurazione sono difficili da guidare, specialmente su superfici sconnesse, e non assicurano una buona stabilità a pieno carico.

3 SWIVEL BRACKETS

This solution provides good load capacity combined with optimal manoeuvrability. Equipment fitted in this way may be difficult to steer, specially on uneven floors. Stability cannot be guaranteed when carrying a high load.

La capacità max di portata è data da = $\frac{\text{peso totale}}{2,5}$

Maximum load on each wheel is given by = $\frac{\text{total weight}}{2,5}$

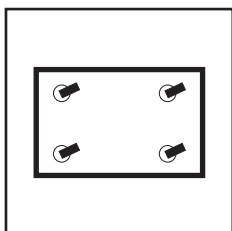

4 SUPPORTI GIREVOLI

Questa soluzione offre una buona capacità di carico ed un'ottima manovrabilità in spazi limitati. Non è consigliata per percorsi lineari e su piani inclinati. Il corretto stazionamento del carrello non è assicurato anche se due supporti sono dotati di dispositivo frenante. La capacità max di portata è data da = $\frac{\text{peso totale}}{3}$

4 SWIVEL BRACKETS

This solution provides good load capacity combined with optimal manoeuvrability. It is not recommended for applications where use on straight runs or ramps is required. The correct functioning of the device cannot be guaranteed if two brackets are fitted with a front brake.. Maximum load on each wheel is given by = $\frac{\text{total weight}}{3}$

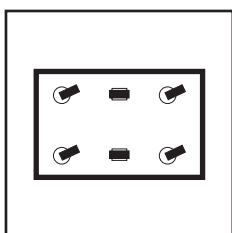

4 SUPPORTI GIREVOLI + 2 SUPPORTI FISSI CENTRALI

Questa soluzione offre un'elevata capacità di carico ed un'eccellente manovrabilità. E' raccomandata per carrelli di grandi dimensioni ed alte portate. Consente di effettuare la spinta da entrambi i lati con supporti girevoli. La capacità max di portata è data da = $\frac{\text{peso totale}}{4}$

4 SWIVEL BRACKETS AND 2 FIXED BRACKETS CENTRALLY PIVOTING

This solution provides high load capacity and excellent manoeuvrability. This is the recommended solution for long trolleys carrying heavy loads. Maximum load on each wheel is given by = $\frac{\text{total weight}}{4}$

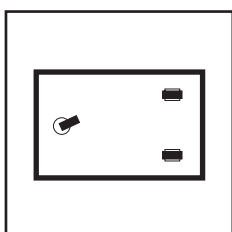

1 SUPPORTO GIREVOLE + 2 SUPPORTI FISSI

Questa soluzione economica offre una portata limitata e una buona manovrabilità. I carrelli con questa configurazione sono poco stabili, specialmente a piena portata e il carico deve essere equamente distribuito.

1 SWIVEL CASTOR AND 2 FIXED BRACKETS

This solution provides low load capacity and good manoeuvrability. Equipment fitted in this way may be unstable when loaded. The load should be evenly distributed.

La capacità max di portata è data da = $\frac{\text{peso totale}}{2,5}$

Maximum load on each wheel is given by = $\frac{\text{total weight}}{2,5}$

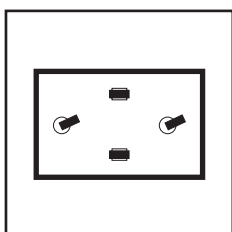

2 SUPPORTI GIREVOLI + 2 SUPP. FISSI CENTRALI

Questa soluzione offre una buona capacità di carico ed un'eccellente manovrabilità. E' raccomandata per carrelli utilizzati in condizioni di spazio limitato. Il carico maggiore viene sopportato dalle due ruote fisse centrali, mentre le girevoli si appoggiano alternativamente con sbalzo di almeno 25 mm.

2 SWIVEL BRACKETS AND 2 FIXED BRACKETS CENTRALLY PIVOTING

This solution provides good load capacity and excellent manoeuvrability. This is the recommended solution for equipment working in limited space. The two central fixed brackets require 25 mm packing to allow alternate support by the swivel brackets.

La capacità max di portata è data da = $\frac{\text{peso totale}}{2}$

Maximum load on each wheel is given by = $\frac{\text{total weight}}{2}$

**COMPATIBILITÀ
CHIMICA**

**CHEMICAL RESISTANCE
OF WHEELS**

Le ruote F.I.R. sono prodotte utilizzando esclusivamente materiali di prima scelta, studiati e sviluppati per rispondere alle più svariate esigenze di resistenza agli agenti esterni.

La tavola seguente è utile per individuare il prodotto più adeguato all'ambiente di lavoro.

F.I.R. wheels are manufactured exclusively from the highest quality materials which have been specifically developed to be usable in the widest range of applications, even in adverse environments.

The table below may help identify the appropriate wheel according to environment.

COMPATIBILITÀ CHIMICA CHEMICAL COMPATIBILITY

Descrizione: ottima ● buona ● tollerata ● bassa ● non disponibile ○	Acqua	Acido Solforico	Vapore	Acqua di Mare	Acido Fosforico 25%	Petrolio	Benzina	Olio di Oliva	Olio Minerale	Latte	Olio di Lino	Acqua Ossigenata 30%	Acido Cloridrico 10%	Glicerina	Acido Formico	Acqua Distillata 50 °C	Olio Diesel	Acido Citrico	Tetracloruro di Carbonio	Solfuro di Carbonio	Benzene	Ammoniaca 20%	Acetone	Acido Acetico (30%)	
POLGOM	●	●	●	●	●	●	●	●	●	●	●	●	●	●	●	●	●	○	●	○	●	●	●	●	POLGOM
BLACK NYLGOM	●	●	●	●	●	●	●	●	●	●	●	●	●	●	●	●	●	●	●	●	●	●	●	●	BLACK NYLGOM
GREY NYLGOM	●	●	●	●	●	●	●	●	●	●	●	●	●	●	●	●	●	●	●	●	●	●	●	●	GREY NYLGOM
GREY NYLGOM 32	●	●	●	●	●	●	●	●	●	●	●	●	●	●	●	●	●	●	●	●	●	●	●	●	GREY NYLGOM 32
BLUE NYLGOM	●	●	●	●	●	●	●	●	●	●	●	●	●	●	●	●	●	●	●	●	●	●	●	●	BLUE NYLGOM
PHENOLIC	●	●	●	●	○	○	●	●	●	●	○	○	○	○	○	○	○	○	○	○	○	○	○	○	PHENOLIC
HT-RUBBER	●	●	●	●	●	●	●	●	●	●	●	●	●	●	●	●	●	●	●	●	●	●	●	●	HT-RUBBER
NYLON HT	●	●	●	●	●	●	●	●	●	●	●	●	●	●	●	●	●	○	○	○	○	○	○	○	NYLON HT
NYLON	●	●	●	●	●	●	●	●	●	●	●	●	●	●	●	●	●	○	○	○	○	○	○	○	NYLON
SUPERLAN	●	●	●	●	●	●	●	●	●	●	●	●	●	●	●	●	●	●	●	●	●	●	●	●	SUPERLAN
SUPERELAST	●	●	●	●	●	●	●	●	●	●	●	●	●	●	●	●	●	●	●	●	●	●	●	●	SUPERELAST
POLIFLEX	●	●	●	●	●	●	●	●	●	●	●	●	●	●	●	●	●	●	●	●	●	●	●	●	POLIFLEX
ALTEC	●	●	●	●	●	●	●	●	●	●	●	●	●	●	●	●	●	●	●	●	●	●	●	●	ALTEC
BLACK ALGOM	●	●	●	●	●	●	●	●	●	●	●	●	●	●	●	●	●	●	●	●	●	●	●	●	BLACK ALGOM
GHIPOLTEC	●	●	●	●	●	●	●	●	●	●	●	●	●	●	●	●	●	●	●	●	●	●	●	●	GHIPOLTEC
GHITEC	●	●	●	●	●	●	●	●	●	●	●	●	●	●	●	●	●	●	●	●	●	●	●	●	GHITEC
GHISA	●	●	●	●	●	●	●	●	●	●	●	●	●	●	●	●	●	●	●	●	●	●	●	●	GHISA
NYLPOL	●	●	●	●	●	●	●	●	●	●	●	●	●	●	●	●	●	●	●	●	●	●	●	●	NYLPOL
NYL	●	●	●	●	●	●	●	●	●	●	●	●	●	●	●	●	●	○	○	○	○	○	○	○	NYL
ACCTEC	●	●	●	●	●	●	●	●	●	●	●	●	●	●	●	●	●	●	●	●	●	●	●	●	ACCTEC
SANDWICH	●	●	●	●	●	●	●	●	●	●	●	●	●	●	●	●	●	●	●	●	●	●	●	●	SANDWICH
SOFT	●	●	●	●	●	●	●	●	●	●	●	●	●	●	●	●	●	○	○	○	○	○	○	○	SOFT
PNEUS	●	●	●	●	●	●	●	●	●	●	●	●	●	●	●	●	●	○	○	○	○	○	○	○	PNEUS
M-ROLL	●	●	●	●	●	●	●	●	●	●	●	●	●	●	●	●	●	○	○	○	○	○	○	○	M-ROLL
Description: very good ● good ● tolerate ● low ● not available ○	Water	Sulphuric Acid	Steam	Sea Water	Phosphoric Acid 25%	Petroleum	Petrol	Olive Oil	Mineral Oil	Milk	Linseed Oil	Hydrogen Peroxide 30%	Hydrochloric Acid 10%	Glycerine	Formic Acid	Distilled Water 50°C	Diesel Oil	Citric Acid	Carbon Tetrachloride	Carbon Disulphide	Benzene	Ammonia Solution 20%	Acetone	Acetic Acid (30%)	

PORTATA IN FUNZIONE
DELLA TEMPERATURALOAD CAPACITY
AS A FUNCTION OF
TEMPERATURE

	TEMPERATURA °C • TEMPERATURE °C							
	-40/-20	-20/0	0/+20	+20/+40	+40/+60	+60/+80	+80/+120	>+120
	% PORTATA • % LOAD CAPACITY							
POLGOM	-	80	100	100	85	50	-	-
BLACK NYLGOM	40	100	100	100	95	50	-	-
GREY NYLGOM	40	100	100	100	95	50	-	-
GREY NYLGOM 32	-	100	100	100	85	60	-	-
BLUE NYLGOM	40	100	100	100	95	50	-	-
PHENOLIC	50	100	100	100	100	100	100	100
HT-RUBBER	40	100	100	100	100	100	100	100
NYLON HT	-	100	100	100	100	100	90	-
NYLON	50	100	100	100	90	70	60	-
SUPERLAN	-	100	100	100	90	70	40	-
SUPERELAST	-	100	100	100	85	60	-	-
POLIFLEX	-	50	100	100	85	40	-	-
ALTEC	-	100	100	100	90	70	40	-
ALGOM	40	100	100	100	95	50	-	-
GHIPOLTEC	-	100	100	100	90	80	40	-
GHISA	100	100	100	100	100	100	100	100
GHITEC	-	100	100	100	90	80	40	-
NYL ROLLER	50	100	100	100	90	70	60	-
NYLPOL ROLLER	-	100	100	100	90	80	40	-
ACCTEC ROLLER	-	100	100	100	90	80	40	-
M-ROLL	50	100	100	100	90	70	60	-

Le caratteristiche, le illustrazioni e le descrizioni sono indicative e possono subire modifiche senza preavviso.

I prodotti illustrati non implicano necessariamente la loro disponibilità a magazzino.

























































Le prove effettuate sono riferite a prodotti originali e con accessori originali.

















La sostituzione di qualsiasi componente non di produzione F.I.R. potrebbe modificare le prestazioni e invalidare così ogni garanzia.

La F.I.R. non si assume nessuna responsabilità per eventuali danni causati da un uso improprio o dall'uso di accessori non originali.

Le illustrazioni riportate in questo catalogo sono riferite alla produzione standard al momento della redazione e stampa.

Specifications, illustrations, dimensions and descriptions are indicative and subject to variation without prior notice. Products as illustrated herein do not necessarily imply their availability in stock as illustrated. Tests undertaken refer to original products fitted with original accessories. Replacement of any component with one from another manufacturer might modify the results and will invalidate any guarantee. F.I.R. will not assume any responsibility for damage caused by improper use or by replacement fittings other than those supplied by F.I.R. S.r.l. Illustrations shown in this catalogue refer to our standard production range at the time of printing.

SUPPORTO BRACKET КРОНШТЕЙН		RUOTA WHEEL КОЛЕСО		RUOTA CON SUPPORTO BRACKET AND WHEEL КОЛЕСА С КРОНШТЕЙНАМИ			
	Supporto girevole a piastra Top plate swivel bracket Поворотные кронштейны с крепежной площадкой		Diametro ruota Wheel diameter Диаметр колеса	SUPPORTO GIREVOLE A PIASTRA TOP PLATE SWIVEL BRACKET ПОВОРОТНЫЕ КРОНШТЕЙНЫ С КРЕПЕЖНОЙ ПЛОЩАДКОЙ		SUPPORTO GIREVOLE A CODOLO STEM SWIVEL BRACKET ПОВОРОТНЫЙ КРОНШТЕЙН СО СТЕРЖНЕМ	
	Supporto fisso Fixed bracket Неповоротные кронштейны		Larghezza fascia Tread width Ширина колеса		Altezza totale Total height Общая высота		Altezza totale Total height Общая высота
	Diametro ruota consigliata Recommended wheel diameter Рекомендуемый диаметр колеса		Diametro foro Wheel hub diameter Диаметр осевого отверстия		Dimensioni piastra Plate dimensions Размер панели		Diametro codolo Stem diameter Диаметр стержня
	Apertura forcella Fork width Ширина вилки		Lunghezza mozzo Hub length Ширина ступицы		Interasse asole Plate hole distance Расстояние отверстий		Altezza codolo Stem height Высота стержня
	Dimensioni piastra Plate dimensions Размер панели		Diametro sede cuscinetti Bearing seat diameter Диаметр под подшипник		Dimensione asole Plate hole diameter Диаметр отверстий		Diametro piastra Round plate diameter Диаметр панели
	Interasse asole Plate hole distance Расстояние отверстий		Profondità sede cuscinetti Bearing seat depth Ширина подшипника		Disassamento Offset Смещение		Disassamento Offset Смещение
	Foro per assale Axle hole diameter Осевое отверстие	MOZZI HUB СТУПИЦА		SUPPORTO FISSO FIXED BRACKET НЕПОВОРОТНЫЕ КРОНШТЕЙНЫ			
	Supp. girevole a foro passante Bolt hole swivel bracket Поворотный кронштейн под болт		Foro passante Plain bore Подшипник скольжения	SUPPORTO GIREVOLE A FORO PASSANTE BOLT HOLE SWIVEL BRACKET ПОВОРОТНЫЙ КРОНШТЕЙН ПОД БОЛТ			
	Apertura forcella Fork width Ширина вилки		Voccola con bussola With bushes Подшипник скольжения со втулкой		Altezza totale Total height Общая высота		Altezza totale Total height Общая высота
	Diametro piastra Round plate diameter Диаметр панели		Rulli ferro Roller bearing Роликовый подшипник		Dimensioni piastra Plate dimensions Размер панели		Diametro foro Bolt hole diameter Диаметр стержня
	Diametro foro passante Bolt hole diameter Диаметр крепежного отверстия		Rulli inox Inox roller bearing Роликовый подшипник из нержавеющей стали		Interasse asole Plate hole distance Расстояние отверстий		Diametro piastra Round plate diameter Диаметр крепежной панели
	Foro per assale Axle hole diameter Осевое отверстие		Sede cuscinetto Ball bearing seat Под шариковый подшипник		Dimensione asole Plate hole diameter Диаметр отверстий		Disassamento Offset Смещение
	Supp. girevole a codolo Stem swivel bracket Кронштейн с крепежным стержнем		Cuscinetto Ball bearing Шариковый подшипник	ACCESSORI ACCESSORIES АКССЕССУАРЫ			
	Apertura forcella Fork width Ширина вилки	PNEUMATICA PNEUS ПНЕВМАТИКА			Vite Stem screw Резьбовой крепежный стержень		Parafili Threadguards Защитный Кожух
	Diametro piastra Round plate diameter Диаметр панели		Battistrada Profile Профиль				
	Diametro codolo Stem diameter Диаметр отверстия		Pressione atm Pressure Давление				
	Foro per assale Axle hole diameter Осевое отверстие			FRENI BRAKE ТОРМОЗНАЯ СИСТЕМА			
	Freno anteriore Front total brake Позадидущая тормозная система		Portata Load capacity Грузоподъемность		Freno anteriore Front total brake Позадидущая тормозная система		Freno posteriore Rear total brake Впередидущая тормозная система
	Freno posteriore Rear total brake Впередидущая тормозная система		Portata con cuscinetto Load capacity with ball bearing Грузоподъемность с шариковым подшипником				

RUOTA WHEEL КОЛЕСО				SUPPORTO BRACKET КРОНШТЕЙН				PESO WEIGHT Вес	
									
mm inches		mm inches		mm inches		mm inches		kg. lbs	
40 1-9/16"		8 0-5/16"		55 2-5/32"		6 0-15/64"		30 66	
50 1-31/32"		12 0-15/32"		60 2-23/64"		6,5 0-1/4"		40 88	
60 2-23/64"		15 0-19/32"		62 2-7/16"		8 0-1/4"		50 110	
70 2-7/8"		20 0-25/32"		68 2-11/16"		9 0-11/32"		60 132	
80 3-5/32"		25 0-63/64"		75 2-15/16"		11 0-7/16"		75 165	
82 3-7/32"				80 3-5/32"		12 0-15/32"		80 176	
85 3-11/32"				88 3-15/32"		13 0-3/64"		100 220	
100 3-15/16"				90 3-17/32"		14 0-9/16"		110 242	
125 4-59/64"				91 3-19/32"		16 0-5/8"		120 264	
150 5-22/32"		mm inches		93 3-21/32"				130 286	
175 6-7/8"		22 0-7/8"		100 3-15/16"				140 308	
200 7-7/8"		28 1-3/32"		108 4-1/4"				150 330	
225 8-55/64"		40 1-37/64"		110 4-13/32"				160 352	
250 9-27/32"		45 1-25/32"		113 4-29/64"		mm inches		170 374	
300 11-13/16"		50 1-31/32"		125 4-59/64"		17 0-21/32"		180 396	
		55 2-5/32"		127 5		22 0-7/8"		200 440	
		56 2-3/16"		128 5-3/64"		27 1-1/16"		220 485	
mm inches		58 2-9/32"		129 5-5/64"		38 1-1/2"		260 573	
18 0-23/32"		66 2-19/32"		130 5-4/32"		40 1-9/16"		270 595	
22 0-7/8"		70 2-7/8"		132 5-3/16"		42 1-21/32"		280 617	
24 0-15/16"				133 5-1/4"		44 1-47/64"		290 639	
25 0-63/64"				134 5-9/32"		46 1-13/16"		300 661	
28 1-3/32"		mm inches		148 5-27/32"		50 1-31/32"		320 705	
30 1-3/16"		32 1-1/4"		155 6-7/64"		52 2-3/64"		330 727	
32 1-1/4"		35 1-3/8"		156 6-1/8"		54 2-1/8"		400 881	
33 1-5/16"		40 1-9/16"		158 6-7/32"		56 2-3/16"		450 991	
35 1-3/8"		42 1-21/32"		159 6-1/4"		65 2-9/16"		480 1057	
36 1-7/16"		47 1-27/32"		160 6-5/16"		66 2-19/32"		500 1101	
37,5 1-15/32"		52 2-3/64"		164 6-7/16"		74 2-29/32"		600 1322	
38 1-1/2"				165 6-1/2"				620 1366	
40 1-37/64"				170 6-11/16"				650 1432	
45 1-25/32"				181 7-1/8"				700 1543	
48 1-7/9"				183 7-13/64"		mm inches		800 1762	
50 1-31/32"		mm inches		184 7-1/4"		10 0-3/8"		900 1982	
55 2-5/32"		10 0-3/8"		187 7-23/64"		12 0-15/32"		1000 2203	
70 2-7/8"		11 0-7/16"		188 7-13/32"		16 0-5/8"		1050 2313	
80 3-5/32"		12 0-15/32"		193 7-19/32"		20 0-25/32"		1100 2423	
82 3-7/32"		14 0-9/16"		195 7-11/16"		22 0-7/8"		1150 2533	
90 3-17/32"		15 0-19/32"		202 7-61/64"		26 1-1/64"		1200 2643	
100 3-15/16"				205 8-5/64"		29 1-1/8"		1400 3086	
				208 8-3/16"				1500 3306	
				210 8-9/32"				1700 3744	
				212 8-23/64"				1800 3965	
				219 8-5/8"					
				222 8-3/4"					
				233 9-11/64"		mm inches			
				237 9-21/64"		25 0-63/64"			
				243 9-9/16"		50 1-31/32"			
				244 9-39/64"		58 2-9/32"			
				245 9-21/32"		60 2-23/64"			
				288 11-11/32"					
				293 11-17/32"					
				310 12-3/16"					
						mm inches			
				mm inches		32 1-1/4"			
				42x42 1-21/32"x1-21/32"		40 1-9/16"			
				60x60 2-23/64"x2-23/64"		42 1-21/32"			
				100x85 3-5/16"x 3-11/32"		78 3-5/64"			
				135x110 5-10/32"x4-13/32"		103 4-1/16"			
				140x110 5-33/64"x4-13/32"					
				200x160 7-7/8"x 6-5/16"					
						mm inches			
				mm inches		10 0-3/8"			
				30x30 1-3/16"x1-3/16"		12 0-15/32"			
				45x45 1-25/32"x1-25/32"		16 0-5/8"			
				80x60 3-5/12"x 2-23/64"					
				105x80 4-1/8"x 3-5/32"					
				160x120 6-5/16"x4-23/32"					

