



CON SUPPORTO  
MEDIO ZINCATO HT

MEDIUM DUTY HT  
ZINC-PLATED CASTERS



Diagram 1	Diagram 2	Diagram 3	Diagram 4	Diagram 5	Diagram 6	Diagram 7	Diagram 8	Diagram 9	Codice / Code		Agg. al cod. /Add to code		Accessori/Accessories		
									Code	Code	Code	Code	Code	Code	
		-							-	P/29BHT	-		-	-	-
		-							-	P/30BHT	-		-	-	-
		-							-	P/31BHT	-			-	-
		-							-	P/31B20HT	-			-	-
		-							-	P/32BHT	-		-	-	-
		-							-	P/33BHT	-			-	-
		-							-	P/34BHT	-			-	-
		-							-	P/35BHT	-			-	-



Diagram 1	Diagram 2	Diagram 3	Diagram 4	Diagram 5	Diagram 6	Diagram 7	Diagram 8	Diagram 9	Codice / Code		Agg. al cod. /Add to code		Accessori/Accessories		
									Code	Code	Code	Code	Code	Code	
		-					-		-	L/39BHT	-	-	-	-	-
		-					-		-	L/40BHT	-	-	-	-	-
		-					-		-	L/41BHT	-	-	-	-	-
		-					-		-	L/41B20HT	-	-	-	-	-
		-					-		-	L/42BHT	-	-	-	-	-
		-					-		-	L/43BHT	-	-	-	-	-
		-					-		-	L/44BHT	-	-	-	-	-
		-					-		-	L/45BHT	-	-	-	-	-

CON SUPPORTO  
MEDIO ZINCATO HT

MEDIUM DUTY HT  
ZINC-PLATED CASTERS



Ø	H	L	W	W	W	W	H	H	H	Codice / Code		Agg. al cod. /Add to code		Accessori/Accessories
										FO		FA	FP	
80	35	-	110	12	78	40	-	200	-	FO/15BHT	-	FA	-	VT12X40F
100	40	-	130	12	78	42	-	230	-	FO/16BHT	-	FA	-	VT12X40F
125	40	-	155	12	78	44	-	240	-	FO/17BHT	-	FA	-	VT12X40F
125	40	-	155	16	103	50	-	260	-	FO/17B20HT	-	FA	FP	VT16X50F
150	40	-	181	12	78	46	-	280	-	FO/18BHT	-	FA	-	VT12X40F
150	40	-	183	16	103	52	-	310	-	FO/19BHT	-	FA	FP	VT16X50F
175	45	-	208	16	103	54	-	350	-	FO/20BHT	-	FA	FP	VT16X50F
200	50	-	233	16	103	56	-	380	-	FO/21BHT	-	FA	FP	VT16X50F

CON SUPPORTO  
PESANTE ZINCATO HT

HEAVY DUTY HT  
ZINC-PLATED CASTERS



Ø	H	-	H	L1	L2	L3	L4	L5	L6	Codice / Code		Agg. al cod. /Add to code		Accessori/Accessories	
										■	■				
80	35	-	113	100X85	80X60	9	38	230	-	PP/29BHT	-	FA	-	-	-
100	40	-	133	100X85	80X60	9	42	300	-	PP/30BHT	-	FA	-	-	-
125	40	-	158	100X85	80X60	9	44	350	-	PP/31BHT	-	FA	-	-	-
125	40	-	159	135X110	105X80	11	50	400	-	PP/31B20HT	-	FA	FP	-	-
150	40	-	184	100X85	80X60	9	46	500	-	PP/32BHT	-	FA	-	-	-
150	40	-	187	135X110	105X80	11	52	580	-	PP/33BHT	-	FA	FP	-	-
175	45	-	212	135X110	105X80	11	54	650	-	PP/34BHT	-	FA	FP	-	-
200	50	-	237	135X110	105X80	11	56	750	-	PP/35BHT	-	FA	FP	-	-



Ø	H	-	H	L1	L2	L3	L4	L5	L6	Codice / Code		Agg. al cod. /Add to code		Accessori/Accessories	
										■	■				
80	35	-	113	100X85	80X60	9	-	230	-	PL/39BHT	-	-	-	-	-
100	40	-	133	100X85	80X60	9	-	300	-	PL/40BHT	-	-	-	-	-
125	40	-	158	100X85	80X60	9	-	350	-	PL/41BHT	-	-	-	-	-
125	40	-	159	135X110	105X80	11	-	400	-	PL/41B20HT	-	-	-	-	-
150	40	-	184	100X85	80X60	9	-	500	-	PL/42BHT	-	-	-	-	-
150	40	-	187	135X110	105X80	11	-	580	-	PL/43BHT	-	-	-	-	-
175	45	-	212	135X110	105X80	11	-	650	-	PL/44BHT	-	-	-	-	-
200	50	-	237	135X110	105X80	11	-	750	-	PL/45BHT	-	-	-	-	-

CON SUPPORTO  
MEDIO INOX HT

MEDIUM DUTY HT  
STAINLESS STEEL CASTERS



⊙	⊙	-	⊙	⊙	⊙	⊙	⊙	⊙	⊙	Codice / Code		Agg. al cod. /Add to code		Accessori/Accessories	
										⊙	⊙	⊙	⊙		
80	35	-	110	100X85	80X60	9	40	200	-	ZK/79B-HT	-	FA	-	-	-
100	40	-	130	100X85	80X60	9	42	230	-	ZK/80B-HT	-	FA	-	-	-
125	40	-	155	100X85	80X60	9	44	240	-	ZK/81B-HT	-	FA	-	-	-
125	40	-	155	135X110	105X80	11	50	260	-	ZK/81B20HT	-	FA	FP	-	-
150	40	-	181	100X85	80X60	9	46	280	-	ZK/82B-HT	-	FA	-	-	-
150	40	-	183	135X110	105X80	11	52	310	-	ZK/83B-HT	-	FA	FP	-	-
175	45	-	208	135X110	105X80	11	54	350	-	ZK/84B-HT	-	FA	FP	-	-
200	50	-	233	135X110	105X80	11	56	380	-	ZK/85B-HT	-	FA	FP	-	-



⊙	⊙	-	⊙	⊙	⊙	⊙	⊙	⊙	⊙	Codice / Code		Agg. al cod. /Add to code		Accessori/Accessories	
										⊙	⊙				
80	35	-	110	100X85	80X60	9	-	200	-	ZX/89B-HT	-	-	-	-	-
100	40	-	130	100X85	80X60	9	-	230	-	ZX/90B-HT	-	-	-	-	-
125	40	-	155	100X85	80X60	9	-	240	-	ZX/91B-HT	-	-	-	-	-
125	40	-	155	135X110	105X80	11	-	260	-	ZX/91B20HT	-	-	-	-	-
150	40	-	181	100X85	80X60	9	-	280	-	ZX/92B-HT	-	-	-	-	-
150	40	-	183	135X110	105X80	11	-	310	-	ZX/93B-HT	-	-	-	-	-
175	45	-	208	135X110	105X80	11	-	350	-	ZX/94B-HT	-	-	-	-	-
200	50	-	233	135X110	105X80	11	-	380	-	ZX/95B-HT	-	-	-	-	-

INOX

CON SUPPORTO  
MEDIO INOX HT

MEDIUM DUTY HT  
STAINLESS STEEL CASTERS



Ø	H	L	W	W	W	W	H	H	Codice / Code		Agg. al cod. /Add to code		Accessori/Accessories		
									NOX/9B-HT		FA		VT1.2X40F		
80	35	-	110	12	78	40	-	200	-	NOX/9B-HT	-	FA	-	VT1.2X40F	-
100	40	-	130	12	78	42	-	230	-	NOX/10B-HT	-	FA	-	VT1.2X40F	-
125	40	-	155	12	78	44	-	240	-	NOX/11B-HT	-	FA	-	VT1.2X40F	-
125	40	-	155	16	103	50	-	260	-	NOX/11B20-HT	-	FA	FP	VT1.6X50F	-
150	40	-	181	12	78	46	-	280	-	NOX/12B-HT	-	FA	-	VT1.2X40F	-
150	40	-	183	16	103	52	-	310	-	NOX/13B-HT	-	FA	FP	VT1.6X50F	-
175	45	-	208	16	103	54	-	350	-	NOX/14B-HT	-	FA	FP	VT1.6X50F	-
200	50	-	233	16	103	56	-	380	-	NOX/15B-HT	-	FA	FP	VT1.6X50F	-

CON SUPPORTO  
PESANTE INOX HT

HEAVY DUTY HT  
STAINLESS STEEL CASTERS



Ø	H	-	Ø	L	W	H	W	W	W	W	Codice / Code		Agg. al cod. /Add to code		Accessori/Accessories	
											—	—				
80	35	-	113	100X85	80X60	9	38	250	-	NK/179BHT	-	FA	-	-	-	-
100	40	-	133	100X85	80X60	9	42	260	-	NK/180BHT	-	FA	-	-	-	-
125	40	-	158	100X85	80X60	9	44	270	-	NK/181BHT	-	FA	-	-	-	-
125	40	-	159	135X110	105X80	11	50	290	-	NK/181B20HT	-	FA	FP	-	-	-
150	40	-	184	100X85	80X60	9	46	350	-	NK/182BHT	-	FA	-	-	-	-
150	40	-	187	135X110	105X80	11	52	400	-	NK/183BHT	-	FA	FP	-	-	-
175	45	-	212	135X110	105X80	11	54	540	-	NK/184BHT	-	FA	FP	-	-	-
200	50	-	237	135X110	105X80	11	56	600	-	NK/185BHT	-	FA	FP	-	-	-



Ø	H	-	Ø	L	W	H	W	W	W	W	Codice / Code		Agg. al cod. /Add to code		Accessori/Accessories	
											—	—				
80	35	-	113	100X85	80X60	9	-	250	-	NX/189BHT	-	-	-	-	-	-
100	40	-	133	100X85	80X60	9	-	260	-	NX/190BHT	-	-	-	-	-	-
125	40	-	158	100X85	80X60	9	-	270	-	NX/191BHT	-	-	-	-	-	-
125	40	-	159	135X110	105X80	11	-	290	-	NX/191B20HT	-	-	-	-	-	-
150	40	-	184	100X85	80X60	9	-	350	-	NX/192BHT	-	-	-	-	-	-
150	40	-	187	135X110	105X80	11	-	400	-	NX/193BHT	-	-	-	-	-	-
175	45	-	212	135X110	105X80	11	-	540	-	NX/194BHT	-	-	-	-	-	-
200	50	-	237	135X110	105X80	11	-	600	-	NX/195BHT	-	-	-	-	-	-







**Fabbrica Italiana Ruote**

[www.fir.it](http://www.fir.it)

! " # \$ % & ' ( i \$ " i ) \* + , " i , - +  
**TECHNICAL INFORMATION**



**FORO PASSANTE**

Consigliato per usi intermittenti. Rumorosità e cigolio possono verificarsi in caso di utilizzo in ambienti sporchi o polverosi. Scarso spunto di partenza.

**PLAIN BEARING**

*Suggested for intermittent wheel use, this does not require further lubrication. However axle tube wear and squeaking can be evident in dusty and gritty work conditions.*

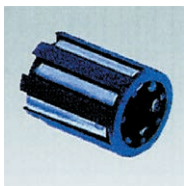

**RULLI FERRO**

Consigliato per usi frequenti. Ideale per applicazioni con elevato carico. La gabbia a rulli è protetta da entrambi i lati. Buono spunto di partenza.

**ROLLER BEARING**

*Suggested for frequent wheel use, this does not require further lubrication. It is ideal for applications involving high radial and low axial loads. Roller bearings are shielded to retain the bearing and to avoid penetration of dust and dirt.*

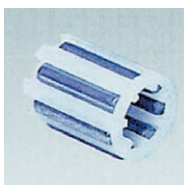

**RULLI INOX**

Consigliato per usi frequenti. Ideale per applicazioni con elevato carico. La gabbia a rulli è protetta da entrambi i lati. Buono spunto di partenza.

**STAINLESS STEEL ROLLER BEARING**

*Suggested for continuous wheel use, this does not require further lubrication. It is ideal for applications involving high radial and low axial loads. Roller bearings are shielded to retain the bearing and to avoid penetration of dust.*



**CUSCINETTI A SFERE**

Consigliato per usi continui. Ideale per applicazioni con massimi carichi. I cuscinetti sono schermati o stagni per evitare l'introduzione di sporco e polvere. Ottimo spunto di partenza.

**BALL BEARINGS**

*Suggested for continuous wheel use, they do not require further lubrication. They are ideal for applications featuring high radial and axial loads. Ball bearings are shielded to avoid penetration of dust and dirt. Waterproof version also available.*



**BOCCOLE TEFLON**

Consigliate su ruote fenoliche per una buona scorrevolezza in ambienti ad alte temperature.

**HT SELFLUBE BUSH**

*Specially designed and developed to fit phenolic wheels, these bushes are self-lubricating even at high temperatures.*



**FRENO ANTERIORE**

Disponibile su supporti tipo leggero, industriale, medio e pesante; blocca simultaneamente la rotazione della ruota e del supporto. Consigliato per carrelli a spinta. Per diametri da 125 a 150 mm, 175 mm larghi, disponibile blocco direzionale.

**FRONT TOTAL BRAKE**

Available for light, industrial, medium and heavy duty casters. These simultaneously lock wheel from rolling and bracket from swiveling. The pedal does not require any further lubrication. Available with directional lock device only in diameters from 125 to 150 mm, 175 mm wide fork.



**FRENO POSTERIORE**

Disponibile su supporti tipo medio, pesante e superpesante; blocca simultaneamente la rotazione della ruota e del supporto. Con possibilità di regolazione. Consigliato per carrelli trainati.

**REAR TOTAL BRAKE**

Available for medium, heavy and extra heavy duty casters. These simultaneously lock wheel from rolling and bracket from swiveling. The steel pedal does not require any further lubrication and is adjustable.



**PARAFILI**

Disponibili per alcune tipologie di ruote proteggono il mozzo dall'introduzione di fili, sporco ecc. Disponibili in acciaio zincato.

**THREADGUARDS**

Available for some wheels ranges, zinc plated steel. They protect the wheel hub from dust, threads etc.



**ASSE E DADO**

Disponibili in acciaio zincato o acciaio inox. Utilizzati per fissare la ruota al supporto.

**SCREW AND NUT**

Available in zinc or stainless steel, they are used to fix the axle bush and wheel to forks. Self locking nuts are available on request.



**BUSSOLA**

Disponibile in acciaio ed acciaio inox, tubo di rotazione della ruota sul supporto. A richiesta è disponibile in acciaio cromato.

**AXLE BUSH**

Available in steel or stainless steel, they are used with plain bearing, roller bearing and ball bearing hubs. Chrome treated bushes are available on request.

## SCORREVOLEZZA

E' la forza necessaria a mantenere un carrello in movimento a velocità costante. La resistenza al rotolamento diminuisce aumentando il diametro della ruota e dipende dal sistema di rotazione del mozzo, dalle condizioni della superficie e dalla portata.

## ROLLING RESISTANCE

Rolling resistance is the force necessary to maintain the equipment at a constant speed. This force is inversely proportional to wheel diameter and depends on the type of bearing. It also depends upon the surface conditions and load.

## SPINTA / TRAZIONE

Tutte le ruote e tutti i supporti F.I.R. sono prodotti esclusivamente per spinta / trazione manuale. Raccomandiamo di rivolgersi al produttore per ruote e supporti da utilizzare per la movimentazione motorizzata.

## MOTIVE POWER

All F.I.R. casters and wheels are specifically manufactured for manual propulsion. Please refer to the manufacturer for wheels and casters required for continuous applications or powered propulsion.

## VELOCITÀ

La portata di ruote e supporti indicata sul presente catalogo è riferita a una velocità max di 4 Km/h ( 1,1 m/s ).

## SPEED

F.I.R. casters and wheels nominal load capacities relate to a maximum speed of 4 Km/h ( 1,1 m/s ) - 2,49 mph (1,2 yds/s)

## PORTATA

Per calcolare la portata di una ruota è utile ricordare queste formule:

### Carrello a 4 ruote

$$\text{Portata} = \frac{\text{Peso del carrello} + \text{carico solido}}{3}$$

$$\text{Portata} = \frac{\text{Peso del carrello} + \text{carico liquido}}{2}$$

Non sempre tutte le 4 ruote del carrello sono a contatto col pavimento. Ad esempio in caso di carico mal distribuito o di pavimentazione irregolare. Per questo motivo nella formula della portata si divide per 3 o per 2. Per carichi al limite delle portate indicate o utilizzi estremi rivolgersi al nostro ufficio tecnico.

## LOAD CAPACITY

To calculate the load capacity of a single caster please use the formula:

### 4 Wheels equipment

$$\text{Load} = \frac{\text{Equipment weight} + \text{solid load}}{3}$$

$$\text{Load} = \frac{\text{Equipment weight} + \text{liquid load}}{2}$$

The 4 wheels may not always touch the floor e.g. if the load is not equally distributed or the floor is not even. For this reason the denominator is 3 or 2. Please apply to our technical staff in relation to load requirements close to the maximum carrying capacities.

## CONDIZIONI DI COLLAUDO

Le portate e i collaudi sono determinati secondo le normative ISO 22884, UNI EN 12527, UNI EN 12532 e si riferiscono a condizioni di utilizzo normali ossia:

- 1) CARICO DI PROVA= portata nominale
- 2) VELOCITÀ DI PROVA= 4Km/h ±50 m/h
- 3) TEMPERATURA AMBIENTE= +15°C ± +28°C
- 4) PAVIMENTO in buono stato, duro e compatto, con ostacoli aventi le seguenti caratteristiche: altezza pari al 5% del diametro della ruota, per fascia di rotolamento morbida (fino 90 Shore A); pari al 2,5% del diametro della ruota, per fascia di rotolamento dura (oltre 90 Shore A).
- 5) CICLO: sequenza di cicli di 3 min. massimo ciascuno compreso un tempo di arresto massimo di 1 min.

## TEST CONDITION

Load capacities and tests are determined according to the ISO 22884, UNI EN 12527, UNI EN 12532 Standards. They refer to use under normal conditions:

- 1) TEST LOAD = nominal load
- 2) TEST SPEED = 4Km/h ±50 m/h - 2,49 mph ±55 yds/h
- 3) TEST TEMPERATURE = +15°C ± +28°C - 59°F ± 82,4°F
- 4) SURFACE in good conditions, hard and solid, with obstacles having the following characteristics: height equal to 5 % of wheel diameter in the case of soft tread (up to 90 Shore A); equal to 2.5% of wheel diameter, in the case of hard tread (beyond 90 Shore A).
- 5) CYCLE: sequence of cycles each 3 minutes maximum, included a maximum pause time of 1 minute.

## CONDIZIONI DI UTILIZZO

Le ruote e supporti F.I.R. sono prodotti con materiali di prima scelta e procedimenti di produzione controllati. Le condizioni standard relative ad un "normale funzionamento" sono:

- temperatura ambiente: da +5 °C a +30 °C
- umidità relativa: da. 40% a 80%
- assenza di agenti chimici aggressivi

## ENVIRONMENT CONDITION

F.I.R. casters and wheels are manufactured in controlled production processes using the highest quality materials. The following standard conditions are considered as "normal working conditions":

- temperature range: +5 °C to +30 °C +41°F to +86° F
- relative humidity: 40% to 80%
- no direct sunlight exposing
- no aggressive physical or chemical agents

## IMMAGAZZINAGGIO

La F.I.R. raccomanda di immagazzinare i propri prodotti in ambiente ventilato, con temperatura compresa fra -10 °C e +30 °C, senza umidità e protetti da polvere; evitare esposizione ai raggi solari per un lungo periodo di tempo.

## STORAGE

F.I.R. recommends that products are stored in a ventilated environment, with temperature between -10 °C -50° F and +30 °C - +86° F, without high humidity and protected from dust. Do not store for long periods of time, and protect from direct sunlight.

**DISPOSITIVO FRENANTE**

IMPORTANTE: i supporti F.I.R. sono disponibili con dispositivo frenante totale e sono idonei per stazionamento del carrello su superfici con pendenze massime del 3% una volta verificato che almeno due ruote con dispositivo siano a contatto con il suolo.

**BRAKING DEVICE**

IMPORTANT: F.I.R. casters are available with total locking systems; all locking devices are suitable for equipment in stationary conditions. Never use the locking devices to reduce speed during normal work and never use them on gradients in excess of 3%. These conditions apply to all equipment with at least 2 casters fitted with locking devices in contact with the floor.

**I FRENI**

I supporti F.I.R. possono essere forniti con freno anteriore o posteriore. L'azionamento dei freni blocca contemporaneamente il movimento della ruota e la rotazione della forcella. Il funzionamento del pedale è garantito anche in condizioni ambientali critiche. L'azionamento e disazionamento del freno è facile e sicuro. Si raccomanda l'utilizzo del freno anteriore o posteriore quando:

- Freno anteriore: il supporto deve essere applicato in carrelli che normalmente sono spinti
- Freno posteriore: il supporto deve essere applicato a carrelli che normalmente sono tirati

I freni anteriori e posteriori non dovrebbero mai essere usati per decelerare il carrello. La loro funzione è quella di mantenere il carrello in posizione quando è fermo.

**TOTAL LOCK BRAKE**

F.I.R. brackets can be supplied with a front or rear total lock brake. This simultaneously locks rolling of the wheel and swivelling of the brackets. The pedal is guaranteed to work in all conditions without locking even in the most adverse environments. Locking and unlocking are very easy and safe. Front and rear total lock brakes are recommended in the following circumstances:

- Front braked brackets: these should be fitted under trolleys which will normally be pushed.
- Rear braked brackets: these should be fitted under trolleys which will normally be pulled.

Total front/rear lock brakes should never be used to reduce the speed of the equipment, but are designed and fitted to hold the position of the trolley once stopped.

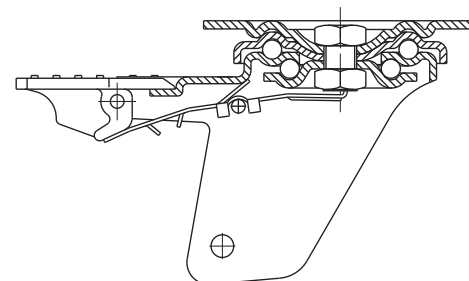
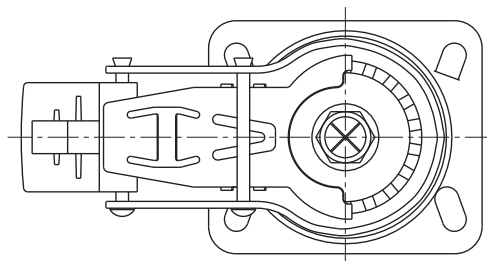
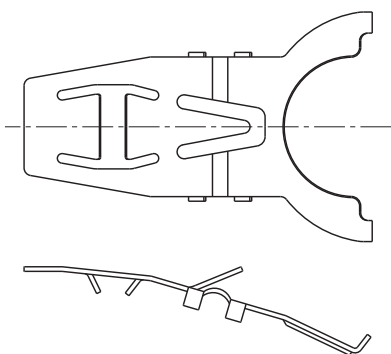

**LUBRIFICAZIONE PERIODICA**

Sebbene le ruote e supporti F.I.R. siano preingrassati, si consiglia una lubrificazione periodica con alcune gocce d'olio per prevenire danni o bloccaggi in caso di utilizzo in condizioni critiche.

**BRACKET AND WHEEL LUBRICATION**

Although F.I.R. casters and wheels are maintenance-free, we recommend that the lubrication be checked periodically. A few drops of machine oil may be used to prevent damage when casters are used in severe conditions.

**APPLICAZIONI / CONDIZIONI SPECIALI**

Per evitare qualsiasi tipo di inconveniente e per utilizzare il miglior prodotto in ciascun campo d'applicazione, consigliamo di interpellare il nostro servizio tecnico.

**SPECIAL APPLICATION AND/OR ENVIRONMENT**

In order to prevent damage and to provide the appropriate caster and wheel in any application, F.I.R. recommends that contact the technical department for information on material resistance and with regard to any special requirements you may have.

I SUPPORTI

BRACKET INFORMATION

I supporti F.I.R. sono prodotti secondo le normative ISO 2184, riguardanti le dimensioni e i fori delle piastre. La nostra gamma di supporti include anche piastre e forcelle con le dimensioni richieste dal mercato nord americano.

F.I.R. brackets are manufactured according to ISO 2184 standards with respect to the top plate and hole dimensions. In response to customer demand, F.I.R. also manufactures a range of plates and forks according to Northern American specifications.

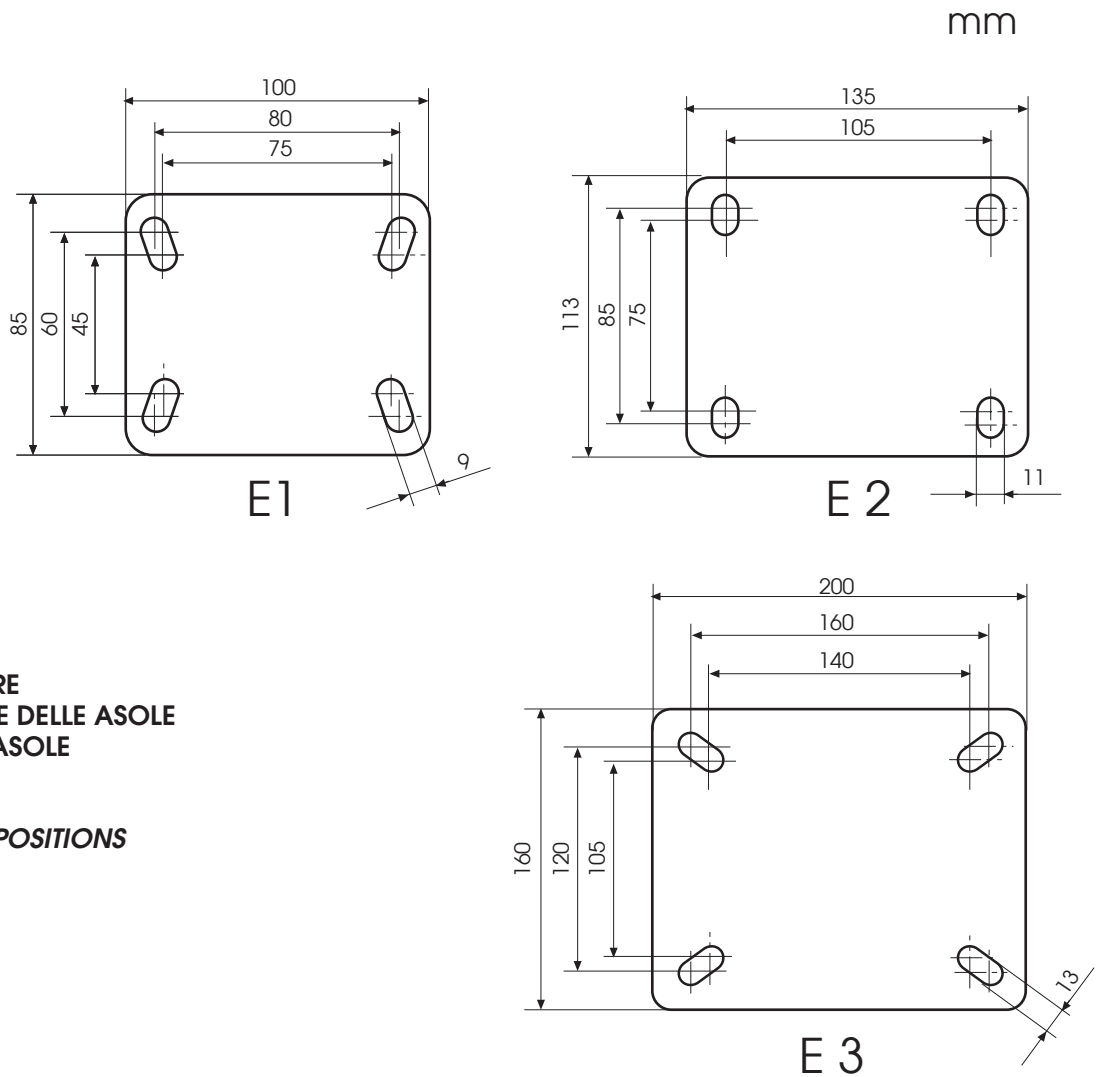

**DIMENSIONI DELLE PIASTRE  
POSIZIONE E DIMENSIONE DELLE ASOLE  
DIMENSIONE INTERASSE ASOLE**

**TOP PLATE DIMENSIONS  
HOLE DIMENSIONS AND POSITIONS  
PLATE HOLE DISTANCE**

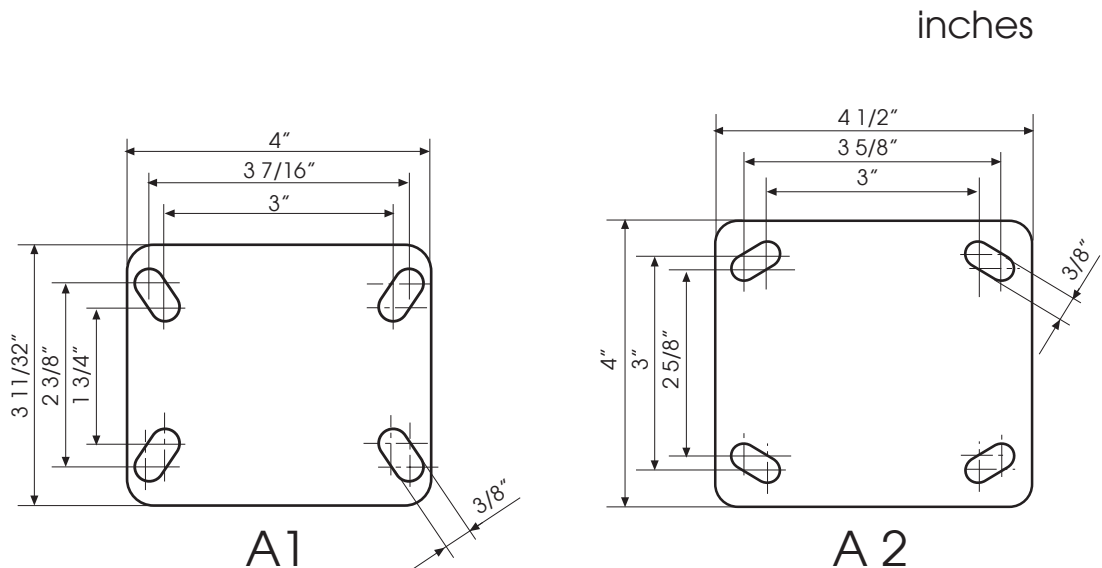
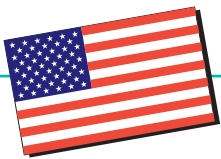

inches

## MONTAGGIO DEI SUPPORTI AL CARRELLO

F.I.R. assicura l'ottimale funzionamento e una lunga durata di ruota e supporto, qualora siano rispettate le seguenti condizioni:

- la ruota deve essere applicata ad un supporto adatto, utilizzando accessori originali e di dimensioni adeguate.
- verifica della libera rotazione dopo aver fissato la ruota.
- i supporti a piastra devono essere fissati utilizzando viti, dadi e rondelle del tipo, dimensione e quantità indicati dal costruttore.
- i supporti a codolo devono essere applicati in strutture tubolari aventi una tolleranza molto stretta.
- i supporti a foro passante devono essere fissati mediante una vite di dimensione e tipo indicati dal costruttore
- la base superiore dei supporti deve aderire perfettamente e per intero al piano di montaggio.

## FITTING BRACKET TO EQUIPMENT

*We guarantee the performance and the life of our wheels and casters, in line with the product warranty, providing the following conditions are fulfilled:*

- *the wheel must be fitted into the correct fork using the original axles, bolts and nuts of the correct dimensions*
- *verification of free rotation of the wheel after fitting*
- *the top plate caster must be fitted with bolts, nuts and washers of the correct size and quantities indicated by the manufacturer.*
- *solid stem casters must be fitted into tubular structures with tight tolerance.*
- *mounting plane surface of bolt hole or threaded casters must adhere perfectly to the mounting plane of the equipment.*
- *bolt hole casters must be fitted using a bolt as recommended by the manufacturer*

## STANDARD

Le ruote ed i supporti F.I.R. sono prodotti in accordo con le seguenti normative:

- ISO 22877 - UNI EN 12526
- ISO 22878 - UNI EN 12527
- ISO 22881 - UNI EN 12530
- ISO 22883 - UNI EN 12532
- ISO 22884 - UNI EN 12533

## ADDITIONAL STANDARDS

*F.I.R. wheels and brackets are manufactured according to the following ISO:*

- ISO 22877 - UNI EN 12526
- ISO 22878 - UNI EN 12527
- ISO 22881 - UNI EN 12530
- ISO 22883 - UNI EN 12532
- ISO 22884 - UNI EN 12533



I prodotti F.I.R. sono prodotti in ottemperanza alla Direttiva Europea 2000/53/CE relativa ai veicoli fuori uso ed alla Direttiva Europea EU 2002/95/CE (RoHS) "Restrizione dell'uso di sostanze pericolose in apparecchiature elettriche ed elettroniche" e alla direttiva REACH (EC) 1907/2006 e successive estensioni, incluso SVHC 2022.



*F.I.R. products are manufactured in compliance with European Directive 2000/53/CE on end-of-life vehicles and European Directive EU 2002/95/CE (RoHS) "Restriction of the use of certain hazardous substances in electrical and electronic equipment" and with regulation REACH (EC) 1907/2006 and following extensions, including SVHC 2022.*



### FIR per l'ambiente

**FIR coniuga qualità, innovazione e rispetto per l'ambiente.**

**A questo proposito, abbiamo identificato i prodotti che possono essere riciclati o rigenerati e ne incoraggiamo l'utilizzo.**

### *FIR for the environment*

***FIR combines quality, innovation and respect for the environment.***

***To this end, we have identified those products that may be recycled or regenerated. We strongly encourage use of these products.***

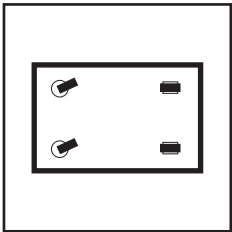

### 2 SUPPORTI GIREVOLI + 2 SUPPORTI FISSI

Questa soluzione offre una buona capacità di carico e manovrabilità. E' una soluzione sicura contro eventuali pericoli di ribaltamento. È l'applicazione più praticata su carrelli per uso industriale. Consigliamo la spinta o trascinamento dal lato delle due ruote girevoli. La capacità max di portata è data da  $\text{da} = \frac{\text{peso totale}}{3}$

### 2 SWIVEL BRACKETS AND 2 FIXED BRACKETS

This solution provides a good load capacity and manoeuvrability; accurate steering is guaranteed. This is the most practical solution for use in industrial trolleys. We suggest that the equipment be pushed from the side of the 2 swivel wheels. Maximum load on each wheel is given by  $= \frac{\text{total weight}}{3}$

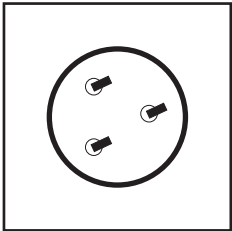

### 3 SUPPORTI GIREVOLI

Questa soluzione offre una buona capacità di carico ed un'ottima manovrabilità in spazi limitati. I carrelli con questa configurazione sono difficili da guidare, specialmente su superfici sconnesse, e non assicurano una buona stabilità a pieno carico.

### 3 SWIVEL BRACKETS

This solution provides good load capacity combined with optimal manoeuvrability. Equipment fitted in this way may be difficult to steer, specially on uneven floors. Stability cannot be guaranteed when carrying a high load.

La capacità max di portata è data da  $\text{da} = \frac{\text{peso totale}}{2,5}$

Maximum load on each wheel is given by  $= \frac{\text{total weight}}{2,5}$

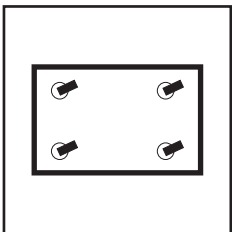

### 4 SUPPORTI GIREVOLI

Questa soluzione offre una buona capacità di carico ed un'ottima manovrabilità in spazi limitati. Non è consigliata per percorsi lineari e su piani inclinati. Il corretto stazionamento del carrello non è assicurato anche se due supporti sono dotati di dispositivo frenante. La capacità max di portata è data da  $\text{da} = \frac{\text{peso totale}}{3}$

### 4 SWIVEL BRACKETS

This solution provides good load capacity combined with optimal manoeuvrability. It is not recommended for applications where use on straight runs or ramps is required. The correct functioning of the device cannot be guaranteed if two brackets are fitted with a front brake.. Maximum load on each wheel is given by  $= \frac{\text{total weight}}{3}$

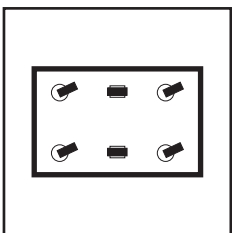

### 4 SUPPORTI GIREVOLI + 2 SUPPORTI FISSI CENTRALI

Questa soluzione offre un'elevata capacità di carico ed un'eccellente manovrabilità. E' raccomandata per carrelli di grandi dimensioni ed alte portate. Consente di effettuare la spinta da entrambi i lati con supporti girevoli. La capacità max di portata è data da  $\text{da} = \frac{\text{peso totale}}{4}$

### 4 SWIVEL BRACKETS AND 2 FIXED BRACKETS CENTRALLY PIVOTING

This solution provides high load capacity and excellent manoeuvrability. This is the recommended solution for long trolleys carrying heavy loads. The two central fixed brackets require 25 mm packing to allow alternate support by the swivel brackets. Maximum load on each wheel is given by  $= \frac{\text{total weight}}{4}$

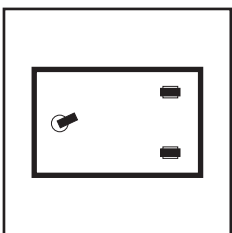

### 1 SUPPORTO GIREVOLE + 2 SUPPORTI FISSI

Questa soluzione economica offre una portata limitata e una buona manovrabilità. I carrelli con questa configurazione sono poco stabili, specialmente a piena portata e il carico deve essere equamente distribuito.

### 1 SWIVEL CASTER AND 2 FIXED BRACKETS

This solution provides low load capacity and good manoeuvrability. Equipment fitted in this way may be unstable when loaded. The load should be evenly distributed.

La capacità max di portata è data da  $\text{da} = \frac{\text{peso totale}}{2,5}$

Maximum load on each wheel is given by  $= \frac{\text{total weight}}{2,5}$

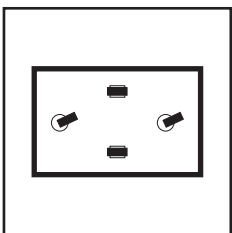

### 2 SUPPORTI GIREVOLI + 2 SUPP. FISSI CENTRALI

Questa soluzione offre una buona capacità di carico ed un'eccellente manovrabilità. E' raccomandata per carrelli utilizzati in condizioni di spazio limitato. Il carico maggiore viene sopportato dalle due ruote fisse centrali, mentre le girevoli si appoggiano alternativamente con sbalzo di almeno 15 mm. La capacità max di portata è data da  $\text{da} = \frac{\text{peso totale}}{2}$

### 2 SWIVEL BRACKETS AND 2 FIXED BRACKETS CENTRALLY PIVOTING

This solution provides good load capacity and excellent manoeuvrability. This is the recommended solution for equipment working in limited space. The two central fixed brackets require 25 mm packing to allow alternate support by the swivel brackets. Maximum load on each wheel is given by  $= \frac{\text{total weight}}{2}$





PORTATA IN FUNZIONE  
DELLA TEMPERATURALOAD CAPACITY  
AS A FUNCTION OF  
TEMPERATURE

TEMPERATURA °C • TEMPERATURE °C								
	-40/-20	-20/0	0/+20	+20/+40	+40/+60	+60/+80	+80/+120	>+120
% PORTATA • % LOAD CAPACITY								
<b>NYLGOM</b>	40	100	100	100	95	50	-	-
<b>BLUE NYLGOM</b>	40	100	100	100	95	50	-	-
<b>PHENOLIC</b>	50	100	100	100	100	100	100	100
<b>HT-RUBBER</b>	40	100	100	100	100	100	100	100
<b>NYLON HT</b>	-	100	100	100	100	100	90	-
<b>NYLON</b>	50	100	100	100	90	70	60	-
<b>NYLON COMPACT</b>	50	100	100	100	90	70	60	-
<b>SUPERLAN</b>	-	100	100	100	90	70	40	-
<b>SUPERLAN COMPACT</b>	-	100	100	100	90	70	40	-
<b>SUPERLAST</b>	-	100	100	100	85	60	-	-
<b>POLIFLEX</b>	-	50	100	100	85	40	-	-
<b>ALTEC</b>	-	100	100	100	90	70	40	-
<b>ALGOM</b>	40	100	100	100	95	50	-	-
<b>GHIPOL</b>	-	100	100	100	90	80	40	-
<b>GHISA</b>	100	100	100	100	100	100	100	100
<b>GHITEC</b>	-	100	100	100	90	80	40	-
<b>NYL ROLLER</b>	50	100	100	100	90	70	60	-
<b>NYLPOL ROLLER</b>	-	100	100	100	90	80	40	-
<b>ACCTEC ROLLER</b>	-	100	100	100	90	80	40	-
<b>M-ROLL</b>	50	100	100	100	90	70	60	-

Le caratteristiche, le illustrazioni e le descrizioni sono indicative e possono subire modifiche senza preavviso.

I prodotti illustrati non implicano necessariamente la loro disponibilità a magazzino.

Le prove effettuate sono riferite a prodotti originali e con accessori originali.

La sostituzione di qualsiasi componente non di produzione F.I.R. potrebbe modificare le prestazioni e invalidare così ogni garanzia.

















La F.I.R. non si assume nessuna responsabilità per eventuali danni causati da un uso improprio o dall'uso di accessori non originali.

Le illustrazioni riportate in questo catalogo sono riferite alla produzione standard al momento della redazione e stampa.

*Specifications, illustrations, dimensions and descriptions are indicative and subject to variation without prior notice. Products as illustrated herein do not necessarily imply their availability in stock as illustrated. Tests undertaken refer to original products fitted with original accessories. Replacement of any component with one from another manufacturer might modify the results and will invalidate any guarantee. F.I.R. will not assume any responsibility for damage caused by improper use or by replacement fittings other than those supplied by F.I.R. S.r.l.*

*Illustrations shown in this catalogue refer to our standard production range at the time of printing.*

TAVOLE DI CONVERSIONE • CONVERSION TABLES

RUOTA WHEEL				SUPPORTO BRACKET		PORTATA LOAD CAPACITY	
							
mm inches		mm inches		mm inches		mm inches	kg. lbs
40 1-9/16"		8 0-5/16"		55 2-5/32"		6 0-15/64"	30 66
50 1-31/32"		12 0-15/32"		60 2-23/64"		6,5 0-1/4"	40 88
60 2-23/64"		15 0-19/32"		62 2-7/16"		8 0-1/4"	50 110
70 2-7/8"		20 0-25/32"		68 2-11/16"		9 0-11/32"	60 132
80 3-5/32"		25 0-63/64"		75 2-15/16"		11 0-7/16"	75 165
82 3-7/32"				80 3-5/32"		12 0-15/32"	80 176
85 3-11/32"				88 3-15/32"		13 0-3/64"	100 220
100 3-15/16"				90 3-17/32"		14 0-9/16"	110 242
125 4-59/64"				91 3-19/32"		16 0-5/8"	120 264
150 5-22/32"		mm inches		93 3-21/32"			130 286
175 6-7/8"		22 0-7/8"		100 3-15/16"			140 308
200 7-7/8"		28 1-3/32"		108 4-1/4"			150 330
225 8-55/64"		40 1-37/64"		110 4-13/32"			160 352
250 9-27/32"		45 1-25/32"		113 4-29/64"		mm inches	170 374
300 11-13/16"		50 1-31/32"		125 4-59/64"		17 0-21/32"	180 396
		55 2-5/32"		127 5		22 0-7/8"	200 440
		56 2-3/16"		128 5-3/64"		27 1-1/16"	220 485
mm inches		58 2-9/32"		129 5-5/64"		38 1-1/2"	260 573
18 0-23/32"		66 2-19/32"		130 5-4/32"		40 1-9/16"	270 595
22 0-7/8"		70 2-7/8"		132 5-3/16"		42 1-21/32"	280 617
24 0-15/16"				133 5-1/4"		44 1-47/64"	290 639
25 0-63/64"				134 5-9/32"		46 1-13/16"	300 661
28 1-3/32"		mm inches		148 5-27/32"		50 1-31/32"	320 705
30 1-3/16"		32 1-1/4"		155 6-7/64"		52 2-3/64"	330 727
32 1-1/4"		35 1-3/8"		156 6-1/8"		54 2-1/8"	400 881
33 1-5/16"		40 1-9/16"		158 6-7/32"		56 2-3/16"	450 991
35 1-3/8"		42 1-21/32"		159 6-1/4"		65 2-9/16"	480 1057
36 1-7/16"		44 1-21/32"		160 6-5/16"		66 2-19/32"	500 1101
37,5 1-15/32"		47 1-27/32"		164 6-7/16"		74 2-29/32"	600 1322
38 1-1/2"		52 2-3/64"		165 6-1/2"			620 1366
40 1-37/64"				170 6-11/16"			650 1432
45 1-25/32"				181 7-1/8"			700 1543
48 1-7/9"				183 7-13/64"		mm inches	800 1762
50 1-31/32"		mm inches		184 7-1/4"		10 0-3/8"	900 1982
55 2-5/32"		10 0-3/8"		187 7-23/64"		12 0-15/32"	1000 2203
70 2-7/8"		11 0-7/16"		188 7-13/32"		16 0-5/8"	1050 2313
80 3-5/32"		12 0-15/32"		193 7-19/32"		20 0-25/32"	1100 2423
82 3-7/32"		14 0-9/16"		195 7-11/16"		22 0-7/8"	1150 2533
90 3-17/32"		15 0-19/32"		202 7-61/64"		26 1-1/64"	1200 2643
100 3-15/16"				205 8-5/64"		29 1-1/8"	1400 3086
				208 8-3/16"			1500 3306
				210 8-9/32"			1700 3744
				212 8-23/64"			1800 3965
				219 8-5/8"			
				222 8-3/4"		mm inches	
				233 9-11/64"		25 0-63/64"	
				237 9-21/64"		50 1-31/32"	
				243 9-9/16"		58 2-9/32"	
				244 9-39/64"		60 2-23/64"	
				245 9-21/32"			
				288 11-11/32"			
				293 11-17/32"		mm inches	
				310 12-3/16"		32 1-1/4"	
						40 1-9/16"	
				mm inches		42 1-21/32"	
				42x42 1-21/32"x1-21/32"		78 3-5/64"	
				60x60 2-23/64"x2-23/64"		103 4-1/16"	
				100x85 3-5/16"x3-11/32"			
				135x110 5-10/32"x4-13/32"			
				140x110 5-33/64"x4-13/32"		mm inches	
				200x160 7-7/8"x6-5/16"		10 0-3/8"	
						12 0-15/32"	
				mm inches		16 0-5/8"	
				30x30 1-3/16"x1-3/16"			
				45x45 1-25/32"x1-25/32"			
				80x60 3-5/12"x2-23/64"			
				105x80 4-1/8"x3-5/32"			
				160x120 6-5/16"x4-23/32"			



SUPPORTO BRACKET		RUOTA WHEEL		RUOTA CON SUPPORTO CASTER					
	Supporto girevole a piastra Top plate swivel bracket		Diametro ruota Wheel diameter	<b>SUPPORTO GIREVOLE A PIASTRA TOP PLATE SWIVEL BRACKET</b>		<b>SUPPORTO GIREVOLE A CODOLO STEM SWIVEL BRACKET</b>			
	Supporto fisso Fixed bracket		Larghezza fascia Tread width		Altezza totale Total height		Altezza totale Total height		
	Diametro ruota consigliata Recommended wheel diameter		Diametro foro Wheel hole diameter		Dimensioni piastra Plate dimensions		Diametro codolo Stem diameter		
	Apertura forcella Fork width		Lunghezza mozzo Hub length		Interasse asole Plate hole distance		Altezza codolo Stem height		
	Dimensioni piastra Plate dimensions		Diametro sede cuscinetti Bearing seat diameter		Dimensione asole Plate hole diameter		Diametro piastra Round plate diameter		
	Interasse asole Plate hole distance		Profondità sede cuscinetti Bearing seat depth		Disassamento Offset		Disassamento Offset		
	Foro per assale Axle hole diameter	<b>MOZZO HUB</b>		<b>SUPPORTO FISSO FIXED BRACKET</b>		<b>SUPPORTO GIREVOLE A FORO PASSANTE BOLT HOLE SWIVEL BRACKET</b>			
	Supp. girevole a foro passante Bolt hole swivel bracket		Foro passante Plain bore		Altezza totale Total height		Altezza totale Total height		
	Apertura forcella Fork width		Boccole teflon Teflon bush		Dimensioni piastra Plate dimensions		Diametro foro Bolt hole diameter		
	Diametro piastra Round plate diameter		Boccola con bussola With bushes		Interasse asole Plate hole distance		Diametro piastra Round plate diameter		
	Diametro foro passante Bolt hole diameter		Rulli ferro Roller bearing		Dimensione asole Plate hole diameter		Disassamento Offset		
	Foro per assale Axle hole diameter		Rulli inox Inox roller bearing	<b>ACCESSORI ACCESSORIES</b>					
	Supp. girevole a codolo Stem swivel bracket		Sede cuscinetto Ball bearing seat		Pararifi Threadguards		Vite Stem screw		
	Apertura forcella Fork width		Cuscinetto Ball bearing	<b>PORTATA LOAD CAPACITY</b>				<b>FRENO BRAKE</b>	
	Diametro piastra Round plate diameter	<b>PNEUMATICA PNEUS</b>			Portata Load capacity		Freno posteriore Rear total brake		
	Diametro codolo Stem diameter		Battistrada Profile		Portata con cuscinetto Load capacity with ball bearing		Freno anteriore Front total brake		
	Foro per assale Axle hole diameter		Pressione atm Pressure	<b>FRENO BRAKE</b>					
	Freno anteriore Front total brake								
	Freno posteriore Rear total brake								